

## 1 Introduction

In the previous notes, we went over different file and record representations for data storage. This week, we will introduce index which is a data structure that operates on top of the data files and helps speed up reads on a specific key. You can think of data files as the actual content of a book and a index as the table of content for fast lookup. We use indexes to make queries run faster, especially those that are run frequently. Consider a web application that looks up the record for a user in a Users table based on the username during the login process. An index on the username column will make login faster by quickly finding the row of the user trying to log in. In this course note, we will learn about B+ trees, which is a specific type of index. Here is an example of what a B+ tree looks like:

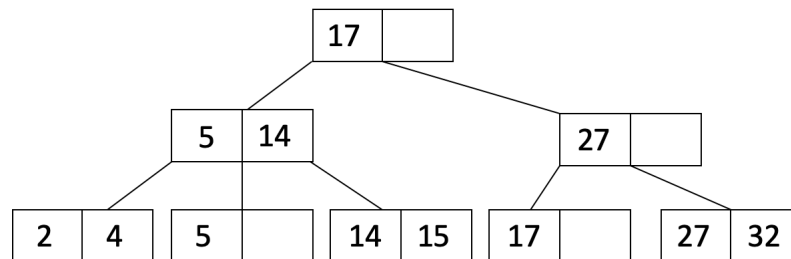

## 2 Properties

- The number  $d$  is the order of a B+ tree. Each node (with the exception of the root node) must have  $d \leq x \leq 2d$  entries assuming no deletes happen (it's possible for leaf nodes to end up with  $< d$  entries if you delete data). The entries within each node must be **sorted**.
- In between each entry of an inner node, there is a pointer to a child node. Since there are at most  $2d$  entries in a node, inner nodes may have at most  $2d + 1$  child pointers. This is also called the tree's fanout.
- The keys in the children to the left of an entry must be less than the entry while the keys in the children to the right must be greater than or equal to the entry.
- All leaves are at the same depth and have between  $d$  and  $2d$  entries (i.e., at least half full)

For example, here is a node of an order  $d = 2$  tree:

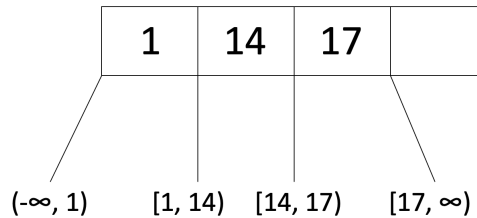

Note that the node satisfies the order requirement ( $d \leq x \leq 2d$ ) because  $d = 2$  and this node has 3 entries which satisfies  $2 \leq x \leq 4$ .

- Because of the sorted and children property, we can traverse the tree down to the leaf to find our desired record. This is similar to BSTs (Binary Search Trees).
- Every root to leaf path has the same number of **edges** - this is the height of the tree. In this sense, B+ trees are **always** balanced. In other words, a B+ tree with just the root node has height 0.
- Only the leaf nodes contain records (or pointers to records - this will be explained later). The inner nodes (which are the non-leaf nodes) do not contain the actual records.

For example, here is an order  $d = 1$  tree:

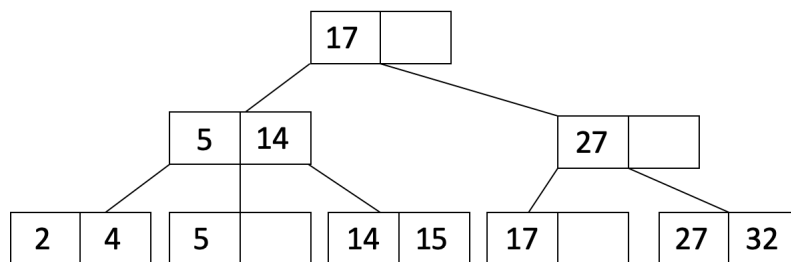

### 3 Insertion

To insert an entry into the B+ tree, follow this procedure:

- (1) Find the leaf node  $L$  in which you will insert your value. You can do this by traversing down the tree. Add the key and the record to the leaf node in order.

- (2) If  $L$  overflows ( $L$  has more than  $2d$  entries)...
  - (a) Split into  $L_1$  and  $L_2$ . Keep  $d$  entries in  $L_1$  (this means  $d + 1$  entries will go in  $L_2$ ).
  - (b) If  $L$  was a leaf node, **COPY**  $L_2$ 's first entry into the parent. If  $L$  was not a leaf node, **MOVE**  $L_2$ 's first entry into the parent.
  - (c) Adjust pointers.
- (3) If the parent overflows, then recurse on it by doing step 2 on the parent. (This is the only case that increases the tree height)

Note: we want to **COPY** leaf node data into the parent so that we don't lose the data in the leaf node. Remember that every key that is in the table that the index is built on must be in the leaf nodes! Being in an inner node does not mean that key is actually still in the table. On the other hand, we can **MOVE** inner node data into parent nodes because the inner node does not contain the actual data, they are just a reference of which way to search when traversing the tree.

Let's take a look at an example to better understand this procedure! We start with the following order  $d = 1$  tree:

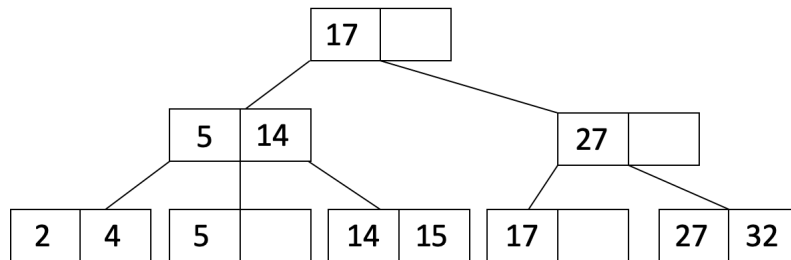

Let's insert 19 into our tree. When we insert 19, we see that there is space in the leaf node with 17:

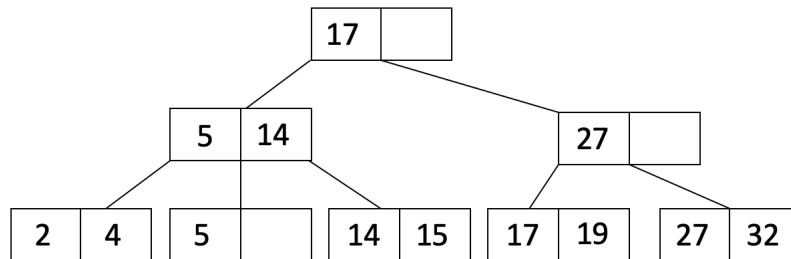

Now let's insert 21 into our tree. When we insert 21, it causes one of the leaf nodes to overflow. Therefore, we split this leaf node into two leaf nodes as shown below:

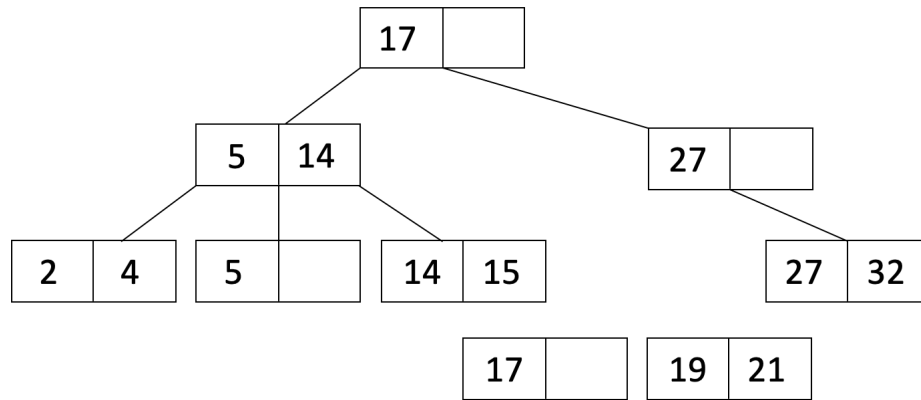

$L_1$  is the leaf node with 17, and  $L_2$  is the leaf node with 19 and 21.

Since we split a leaf node, we will **COPY**  $L_2$ 's first entry up to the parent and adjust pointers. We also sort the entries of the parent to get:

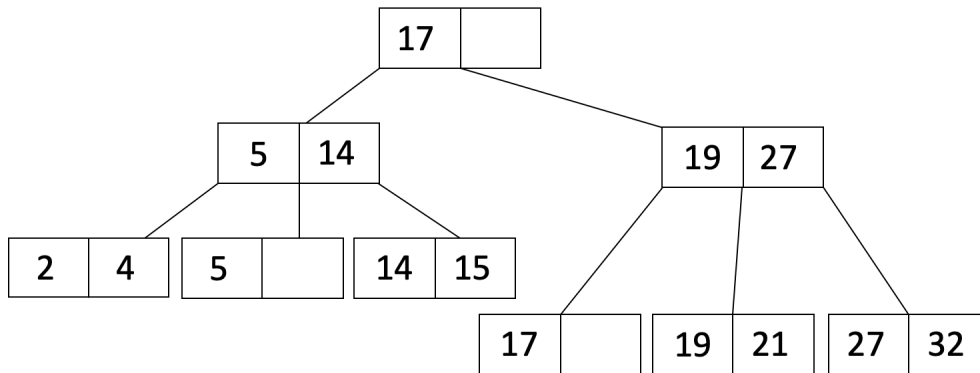

Let's do one more insertion. This time we will insert 36. When we insert 36, the leaf overflows so we will do the same procedure as when we inserted 21 to get:

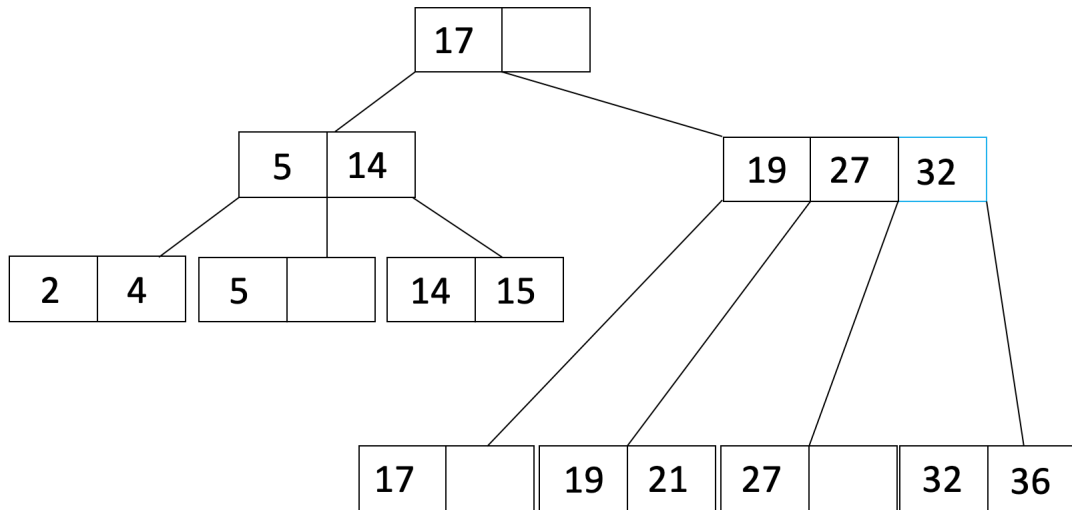

Notice that now the parent node overflowed, so now we must recurse. We will split the parent node to get:

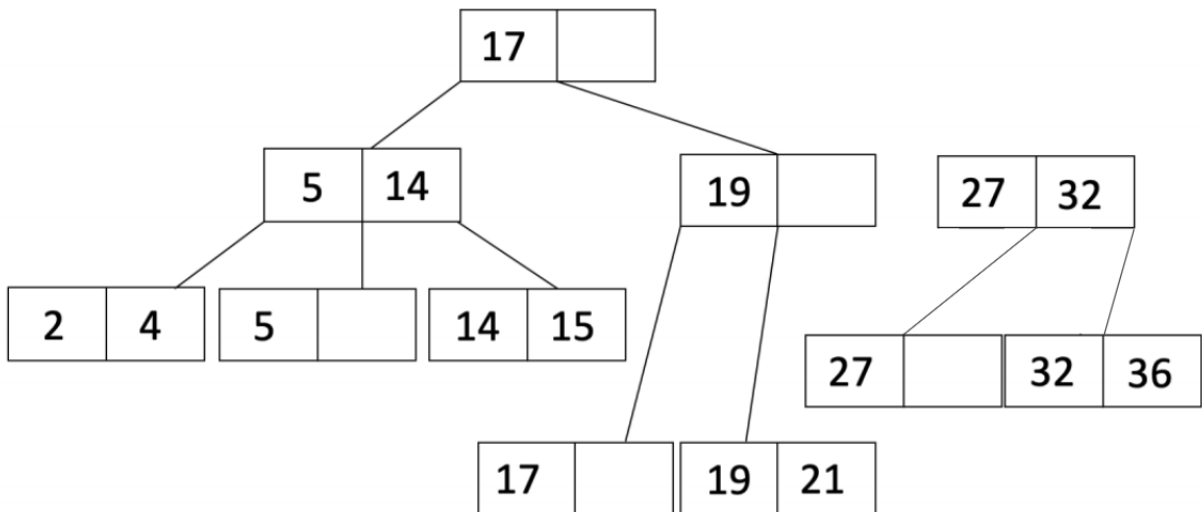

$L_1$  is the inner node with 19, and  $L_2$  is inner the node with 27 and 32.

Since it was an inner node that overflowed, we will **MOVE**  $L_2$ 's first entry up to the parent and adjust pointers to get:

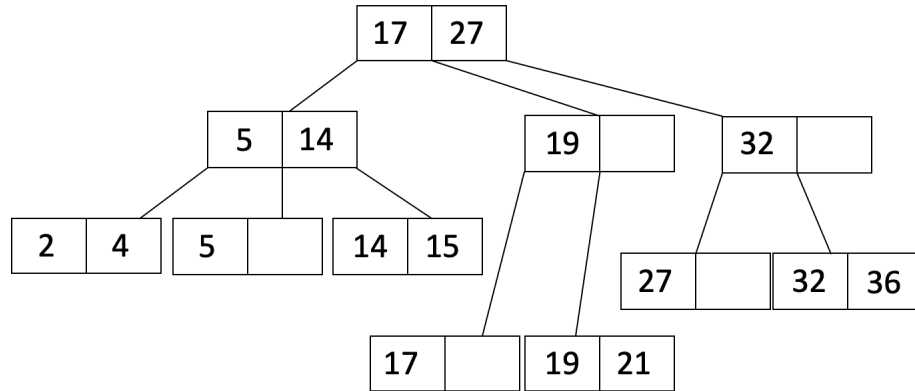

Lastly, here are a couple clarifying notes about insertion into B+ Trees:

- Generally, B+ tree nodes have a minimum of  $d$  entries and a maximum of  $2d$  entries. In other words, if the nodes in the tree satisfy this invariant before insertion (which they generally will), then after insertion, they will continue to satisfy it.
- Insertion overflow of the node occurs when it contains more than  $2d$  entries.

## 4 Deletion

To delete a value, just find the appropriate leaf and delete the unwanted value from that leaf. That's all there is to it. (Yes, technically we could end up violating some of the invariants of a B+ tree. That's okay because in practice we get *way* more insertions than deletions so something will quickly replace whatever we delete.)

Reminder: We never delete inner node keys because they are only there for search and not to hold data.

## 5 Storing Records

Up until now, we have not discussed how the records are actually stored in the leaves. Let's take a look at that now. There are three ways of storing records in leaves:

- **Alternative 1: By Value**

In the Alternative 1 scheme, the leaf pages are the data pages. Rather than containing pointers to records, the leaf pages contain the records themselves.

Points	Name
2	MEM
3	LAK
5	BOS
7	MIL
20	BKL
24	GSW

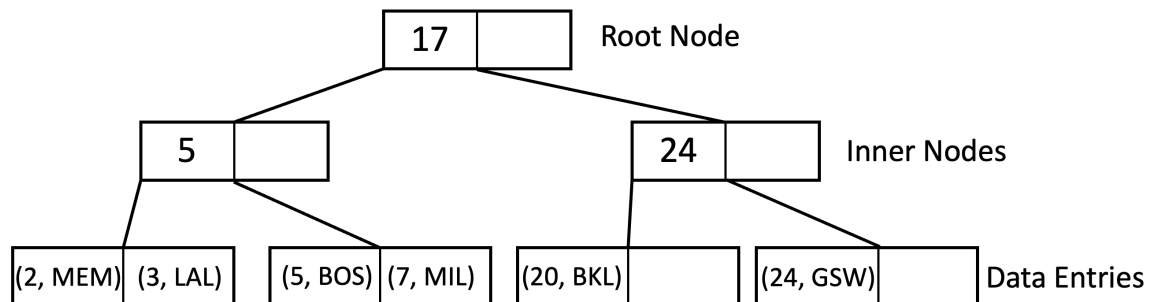

While the Alternative 1 Scheme is perhaps the easiest implementation, it has a significant limitation: if all we have is the Alternative 1 Scheme, we cannot support multiple indexes built on the same file (in the example above we cannot support a secondary index on 'name'). Instead we would have to duplicate the file and build a new Alternative 1 index on top of that file.

- **Alternative 2: By Reference**

In the Alternative 2 scheme, the leaf pages hold pointers to the corresponding records.

Points	Name
2	MEM
3	LAK
5	BOS
7	MIL
20	BKL
24	GSW

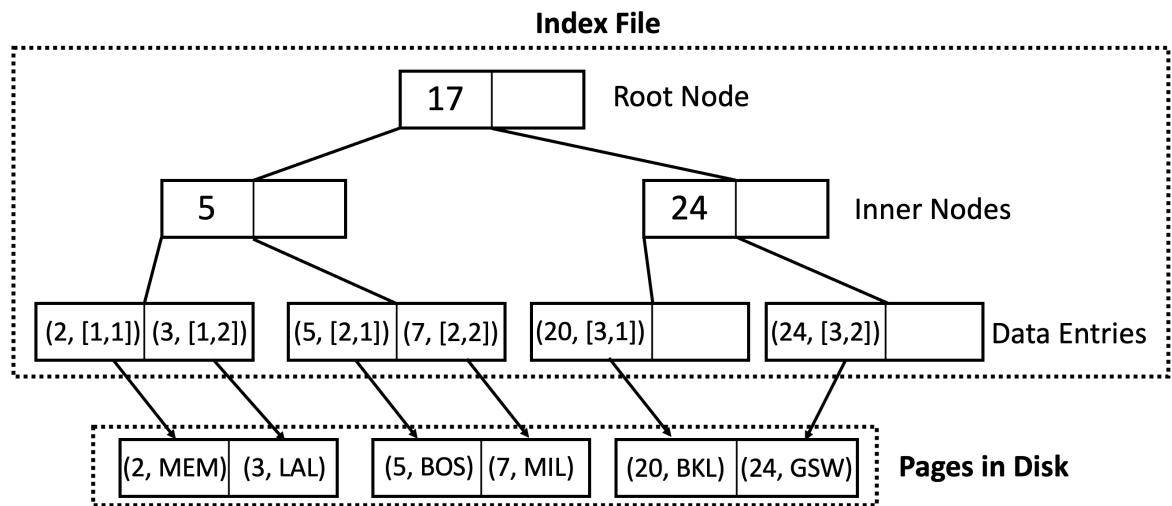

Notation Clarification: In the diagram above, the leafs contain (Key, RecordID) pairs where the RecordID is [PageNum, RecordNum].

Indexing by reference enables us to have multiple indexes on the same file because the actual data can lie in any order on disk.



- **Alternative 3: By List of References**

In the Alternative 3 scheme, the leaf pages hold lists of pointers to the corresponding records. This is more compact than Alternative 2 when there are multiple records with the same leaf node entry. Each leaf now contains (Key, List of RecordID) pairs.

Points	Name
2	MEM
2	LAK
2	BOS
7	MIL
7	BKL
50	GSW

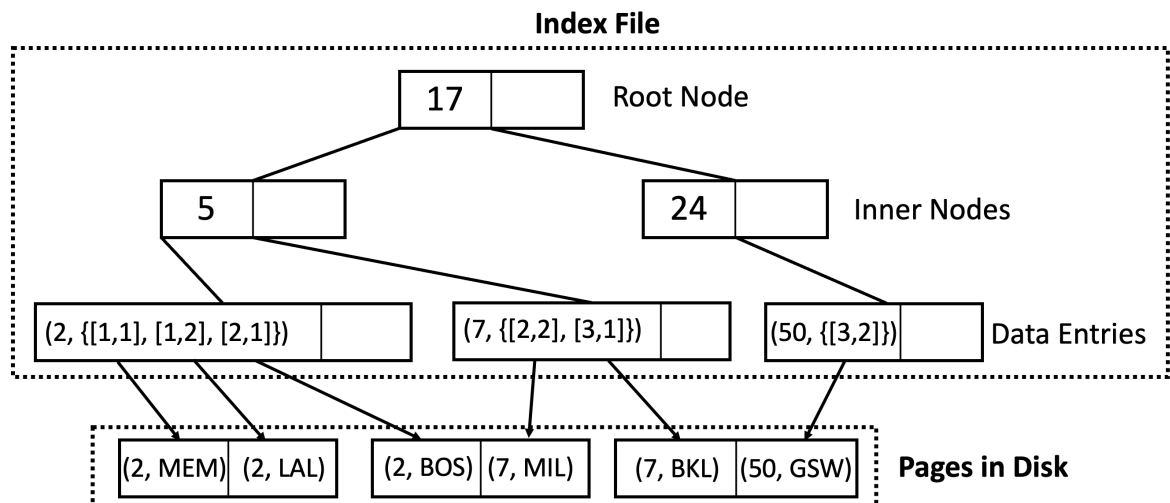

## 6 Clustering

Now that we've discussed how records are stored in the leaf nodes, we will also discuss how data on the data pages are organized. Clustered/unclustered refers to how the data pages are structured. Because the leaf pages are the actual data pages for Alternative 1 and keys are sorted on the index leaf pages, Alternative 1 indices are clustered by default. Therefore, unclustering only applies to Alternative 2 or 3.

- **Unclustered**

In an unclustered index, the data pages are complete chaos. Thus, odds are that you're going to have to read a separate page for each of the records you want. For instance, consider this illustration:

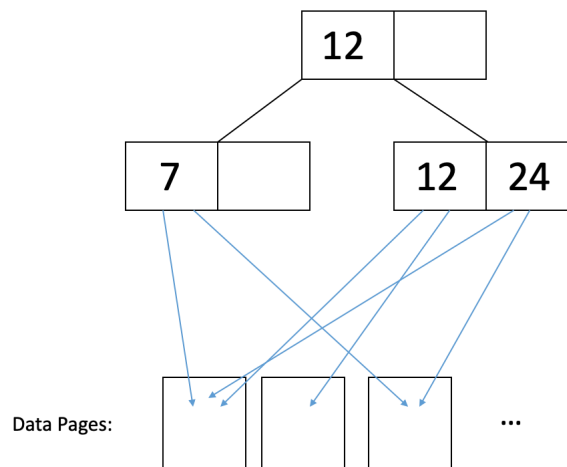

In the figure above, if we want to read records with 12 and 24, then we would have to read in each of the data pages they point to in order to retrieve all the records associated with these keys.

- **Clustered**

In a clustered index, the data pages are sorted on the same index on which you've built your B+ tree. This does not mean that the data pages are sorted exactly, just that keys are roughly in the same order as data. The difference in I/O cost therefore comes from caching, where two records with close keys will likely be in the same page, so the second one can be read from the cached page. Thus, you typically just need to read one page to get all the records that have a common / similar key. For instance, consider this illustration:

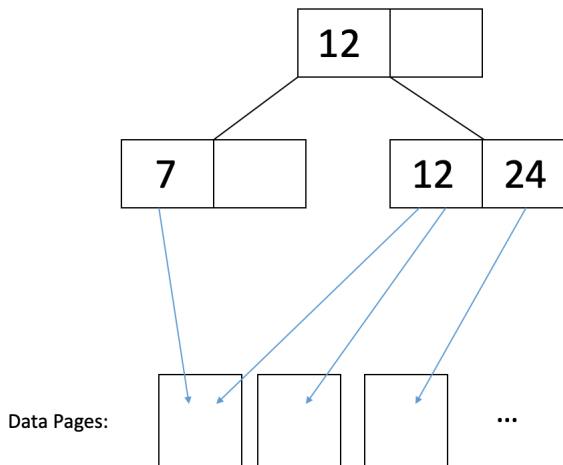

In the figure above, we can read records with 7 and 12 by reading 2 pages. If we do sequential reads of the leaf node values, the data page is largely the same. In conclusion,

- UNCLUSTERED =  $\sim 1$  I/O per record.
- CLUSTERED =  $\sim 1$  I/O per page of records.
- **Clustered vs. Unclustered Indexes**

While clustered indexes can be more efficient for range searches and offer potential locality benefits during sequential disk access and prefetching, etc, they are usually more expensive to maintain than unclustered indexes. For example, the data file can become less clustered with more insertions coming in and, therefore, require periodical sorting of the file.

## 7 Counting IO's

Here's the general procedure. It's a good thing to write on your cheat sheet:

- (1) Read the appropriate root-to-leaf path.
- (2) Read the appropriate data page(s). If we need to read multiple pages, we will allot a read IO for each page. In addition, we account for clustering for Alt. 2 or 3 (see below.)
- (3) Write data page, if you want to modify it. Again, if we want to do a write that spans multiple data pages, we will need to allot a write IO for each page.
- (4) Update index page(s).

Let's look at an example. See the following **Alternative 2 Unclustered** B+ tree:

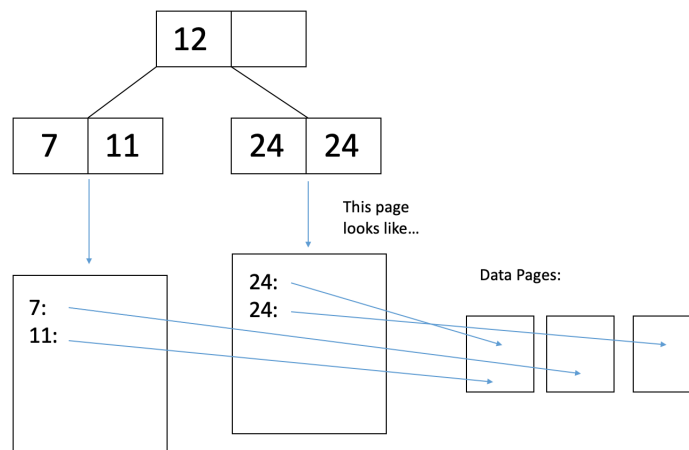

We want to delete the only 11-year-old from our database. How many I/Os will it take?

- One I/O for each of the 2 relevant index pages (an index page is an inner node or a leaf node).
- One I/O to read the data page where the 11-year-old's record is. Once it's in memory we can delete the record from the page.
- One I/O to write the modified data page back to disk.
- Now that there are no more 11-year-olds in our database we should remove the key "11" from the leaf page of our B+ tree, which we already read in Step 1. We do so, and then it takes one I/O to write the modified leaf page to disk.
- Thus, the total cost to delete the record was 5 I/Os.

## 8 Bulk Loading

The insertion procedure we discussed before is great for making additions to an existing B+ tree. If we want to construct a B+ tree from scratch, however, we can do better. This is because if we use the insertion procedure we would have to traverse the tree each time we want to insert something new; regular insertions into random data pages also lead to poor cache efficiency and poor utilization of the leaf pages as they are typically half-empty. Instead, we will use **bulkloading**:

- (1) Sort the data on the key the index will be built on.
- (2) Fill leaf pages until some fill factor  $f$ . Note that fill factor only applies to leaf nodes. For inner nodes, we still follow the same rule to insert until they are full.
- (3) Add a pointer from parent to leaf page. If the parent overflows, we will follow a procedure similar to insertion. We will split the parent into two nodes:
  - (a) Keep  $d$  entries in  $L_1$  (this means  $d + 1$  entries will go in  $L_2$ ).
  - (b) Since a parent node overflowed, we will **MOVE**  $L_2$ 's first entry into the parent.
- (4) Adjust pointers.

Let's look at an example. Let's say our fill factor is  $\frac{3}{4}$  and we want to insert  $1, \dots, 20$  into an order  $d = 2$  tree. We will start by filling a leaf page until our fill factor:

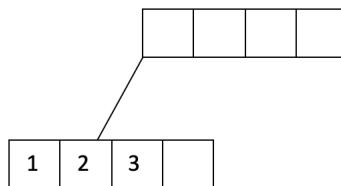

We have filled a leaf node to the fill factor of  $\frac{3}{4}$  and added a pointer from the parent node to the leaf node. Let's continue filling:

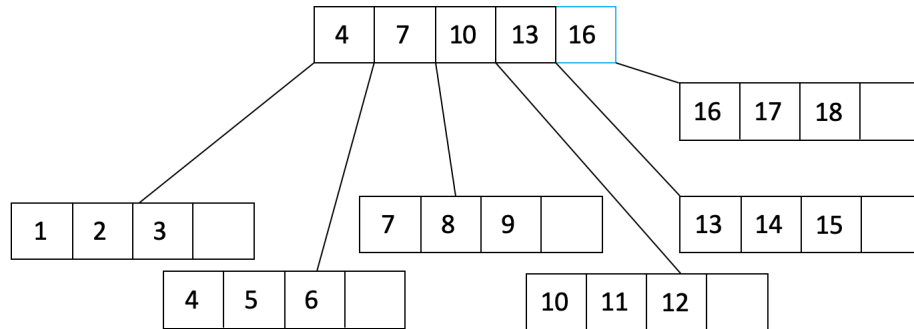

In the figure above, we see that the parent node has overflowed. We will split the parent node into two nodes and create a new parent:

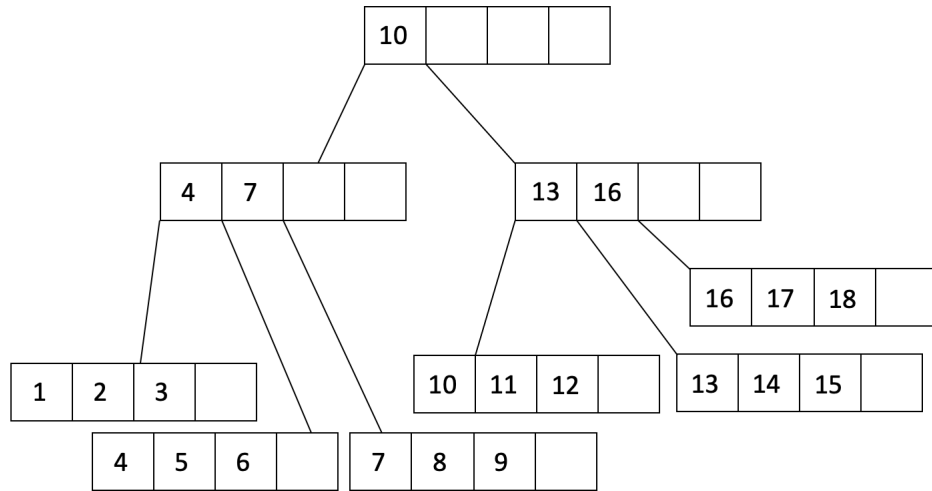

As you can see from the above example, indexes built from bulkloading always start off clustered because the underlying data is sorted on the key. To maintain clustering, we can choose the fill factor depending on future insertion patterns.

## 9 Practice Questions

1. What is the maximum number of entries we can add to the following B+ tree without increasing its height?

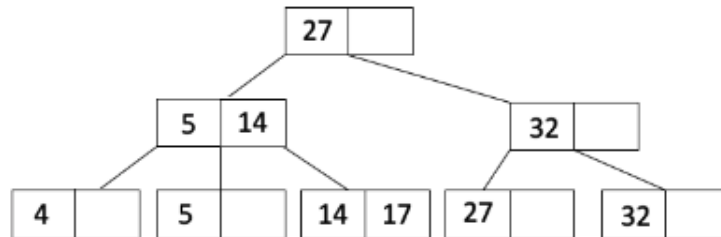

2. What is the minimum number of entries we can add to the B+ tree above which will cause the height to increase?
3. How many I/Os would it cost to insert an entry into our table if we had a height 2, unclustered alternative 3 B+ tree in the worst case? Assume that the cache is empty at the beginning and there are at most 10 entries with the same key. Assume each page is at most  $\frac{2}{3}$  full.
4. Assume we have the following Alternative 2 unclustered B+ tree built over the age field of a relation. How many I/Os will it take to find all records where age  $\geq 6$ ?

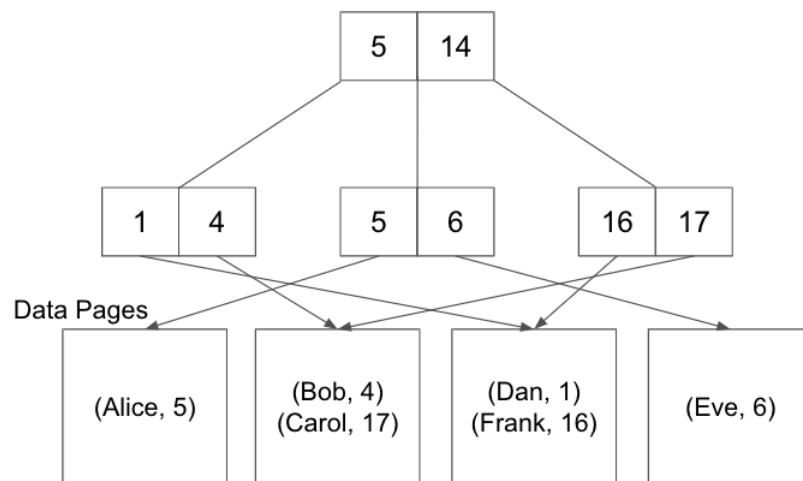

5. What is the maximum fan-out of an order  $d$  B+ tree? Express your answer as a function of  $d$ .



6. What is the maximum number of keys an order 4 B+ tree with height 5 can store? (Remember that a tree of height 0 only contains a root node while a tree of height 1 contains a root node and its leaves.)

## 10 Solutions

1. The maximum number of entries we can add without increasing the height is the total capacity of a height 2, order  $d = 1$  tree minus the current number of entries. The total capacity is  $(2d)(2d + 1)^h = (2)(3^2) = 18$ . The current number of entries is 6 because the entries are in the leaf nodes. Therefore, we can add a maximum of  $18 - 6 = 12$ .
2. The minimum number of entries we can add to cause the height to increase will be 3.  
We will add 20 to the fullest leaf node which is 14, 17 which will cause it to split into 14 and 17, 20. Then we copy 17 to its parent 5, 14, which causes it to split into 5 and 17 and 14 will be pushed up so the root will have 14, 27.  
Then we will insert 21 into the fullest leaf which will now be 17, 20, which will cause it to split into 17 and 20, 21. Then we copy 20 up to its parent which will become 17, 20.  
Then we can insert 22 into the fullest leaf 20, 21 which will split into 20 and 21, 22. Then we copy 21 up to the parent 17, 20, which will cause it to split into 17 and 21 because 20 will be pushed up to its parent (the root). This root will also split because it already has 14, 27. When the root splits, we know that the height has increased.
3. First, we need to check if our table already contains this entry. We will search down the B+ tree for the key which will cost us 3 I/Os because the tree is height 2. Then we get to a leaf node and we see that there are at most 10 entries with the same key. We need to check each of these entries to make sure it's not the same as our current entry which is 10 I/Os because our B+ tree is unclustered. In the worst case, none of the 10 entries match the entry we want to insert so we will have to go ahead and add it to the table. We will add the entry to any page that has space (we already have this page in our cache from the previous part so this does not incur an I/O) and then writing this page back to disk which will cost 1 I/O. We also have to update our B+ tree leaf node to include a pointer to this new entry so we will have to write the node back to disk which is 1 I/O. Therefore, we will have a total of  $3 + 10 + 1 + 1 = 15$  I/Os.
4. 6 I/Os. The general idea is that we need to look up which leaf node corresponds to age = 6 and scan through all leaf nodes to the right. Since this is an Alternative 2 B+ tree, for each leaf node we will also need to read in the data pages the records lie on (1 I/O per matching record since the index is unclustered).

We will incur:

- 1 I/O to read in the root node: 5, 14
- 1 I/O to read in the 5, 6 leaf node
- 1 I/O to read in the 4th data page, which contains (Eve, 6)
- 1 I/O to read in the 16, 17 leaf node

- 1 I/O to read in the 3rd data page, which contains (Frank, 16)
  - 1 I/O to read in the 2nd data page, which contains (Carol, 17)
5. The maximum fan-out is the maximum occupancy plus one,  $2d + 1$  by definition.
  6. 472,392. An order of 4 means that the fan-out is 9. At height 0, there is only one node. At height 1, there are at most  $9^1 = 9$  leaf nodes. At height 2, there are at most  $9^2 = 81$  leaf nodes. At height 5, there are at most  $9^5 = 59,049$  leaf nodes. Each node can store 8 keys. So  $59,049 * 8 = 472,392$  keys.